

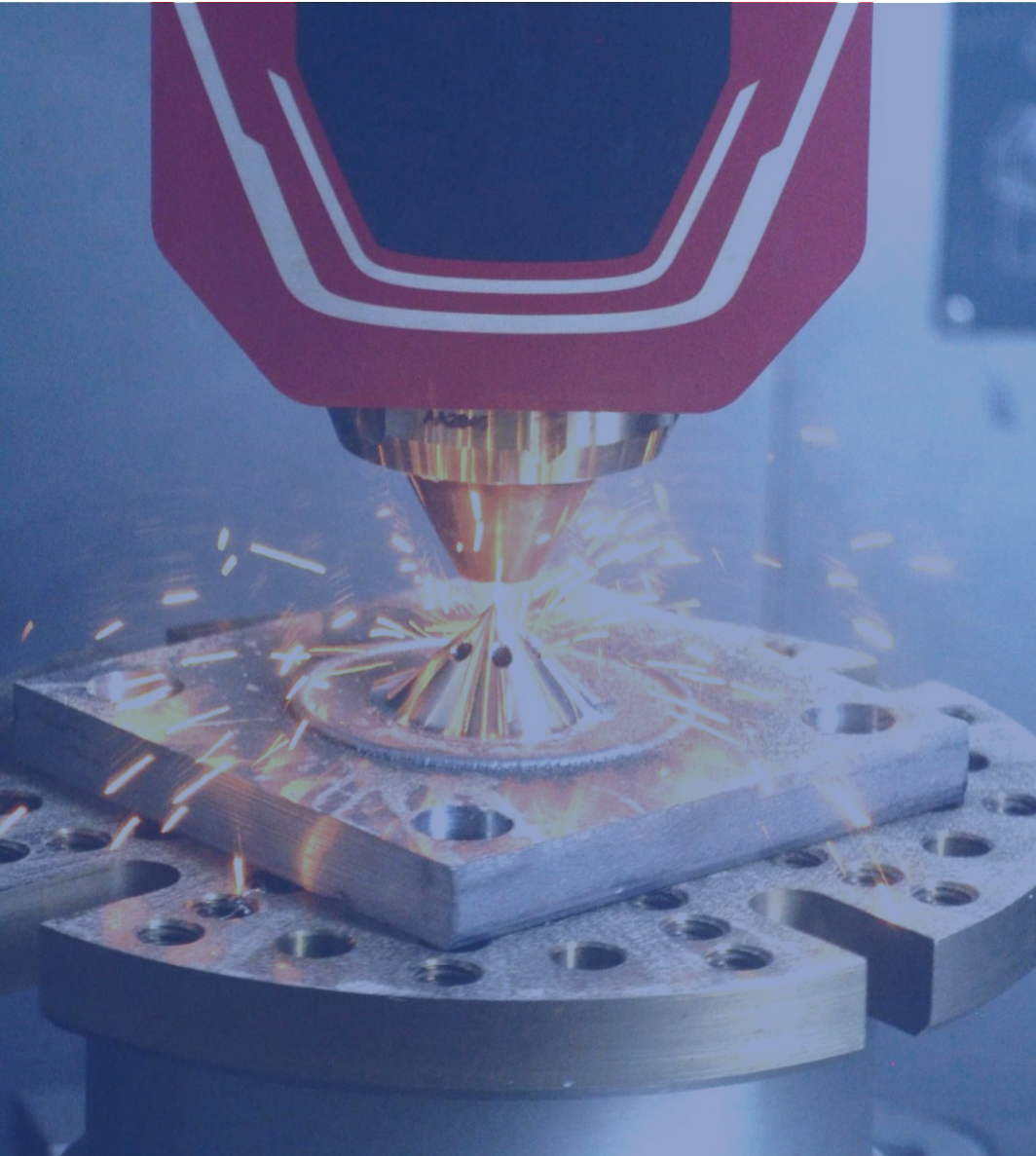

**Tour *Your* Advanced Technology Center  
to Inspire ALL Students**

Tuesday, February 15, 2022 | 1:00 – 3:00 PM



- Opening Remarks
- Advanced Technology Centers Tour
  - Robotics & Polymer Additive
  - Metal Additive
  - Inspection
  - Reflection & Discussion
- Resources and Upcoming Opportunities

CCAT is an applied technology development, demonstration and training center that **innovates, validates, demonstrates,** and **assists with the adoption of leading-edge technologies** into Connecticut and the nation's **advanced manufacturing supply chain**, while providing vital **workforce training and upskilling** necessary to fully-utilize the technology advancement.

## ADVANCED TECHNOLOGY CENTERS

ADAM: Advanced Design  
Automation and Metrology

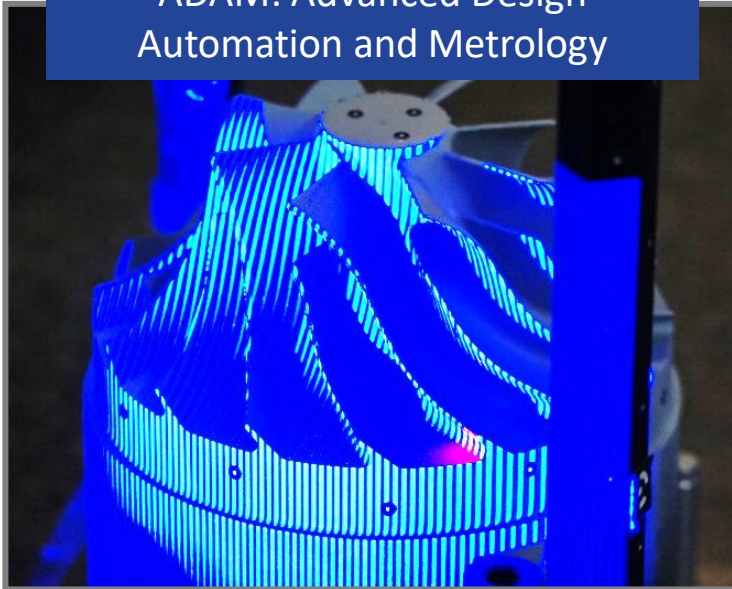

ATOM: Additive Technology  
Optimization and Machining

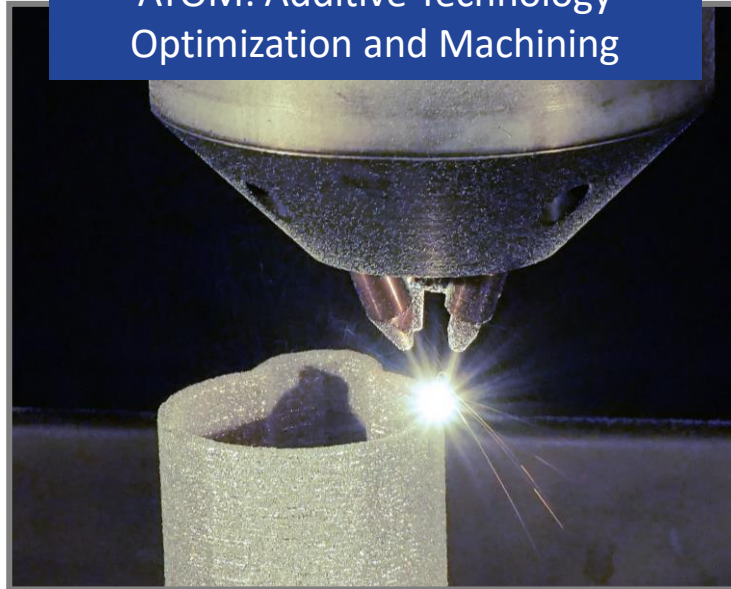

Advanced Composite  
Technology Center



- Demonstrate, Train and Help Companies adopt Industry 4.0 & Digital Technologies
- Foster Industry Partnerships
- Recruitment, Assessment, Job Placement & Retention of underrepresented, young adults, Two-Gen & re-entry populations
- Increase Manufacturing/Technology Awareness

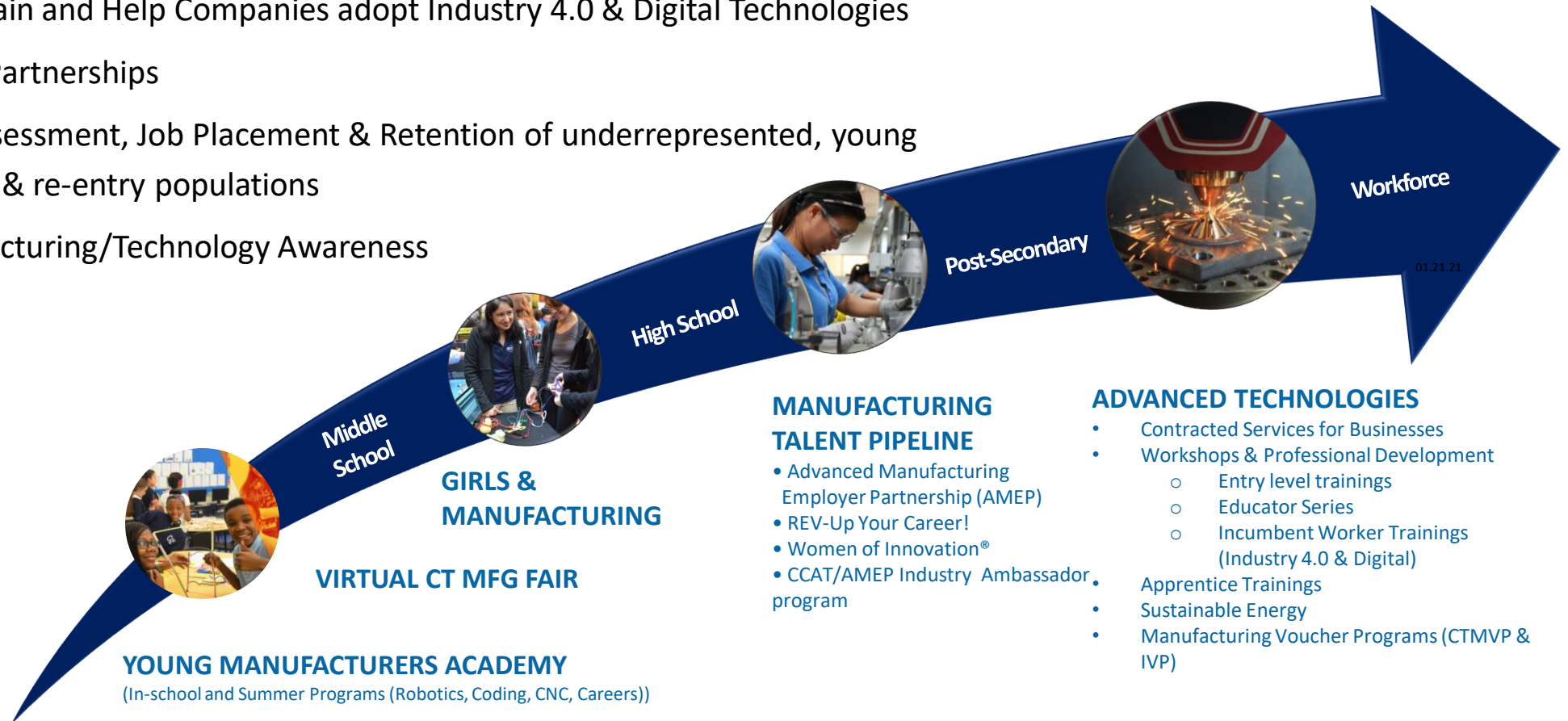

### MANUFACTURING TALENT PIPELINE

- Advanced Manufacturing Employer Partnership (AMEP)
- REV-Up Your Career!
- Women of Innovation®
- CCAT/AMEP Industry Ambassador program

### ADVANCED TECHNOLOGIES

- Contracted Services for Businesses
- Workshops & Professional Development
  - Entry level trainings
  - Educator Series
  - Incumbent Worker Trainings (Industry 4.0 & Digital)
- Apprentices Trainings
- Sustainable Energy
- Manufacturing Voucher Programs (CTMVP & IVP)

Funding has been provided by CT Department of Economic and Community Development's Manufacturing Innovation Fund, Workforce Solutions Collaborative of Metro Hartford, CT Health and Education Facilities Authority (CHEFA), and Capital Workforce Partners (CWP).



**CTcreates.org**

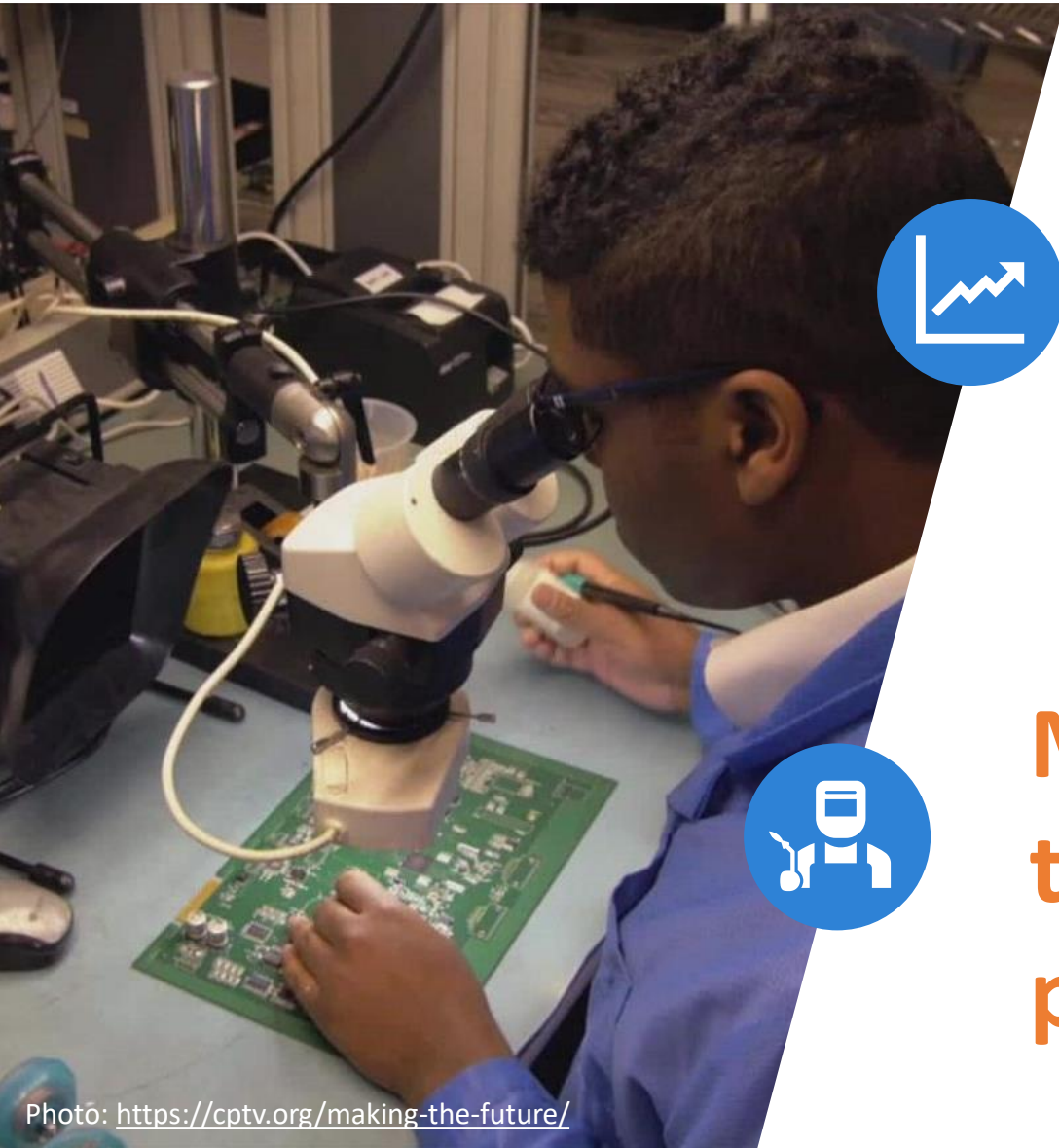

In the next 10 years,  
4.6 million U.S. jobs will  
be open in manufacturing

**But only 2.2 million jobs will be filled**



**Manufacturing has STEAM/  
technology career  
pathways for your students!**



**3,000-4,000 CT students yearly**

- Technical high schools
- HS Manufacturing Programs
- Apprentices
- State Colleges & Universities
- 4-year universities
- Private institutions



**6,000-8,000 skilled workers needed yearly for CT Manufacturing**



**9,000 yearly CT HS graduates are not going on to college or the military**

## Secondary

## Post-secondary

## Workforce

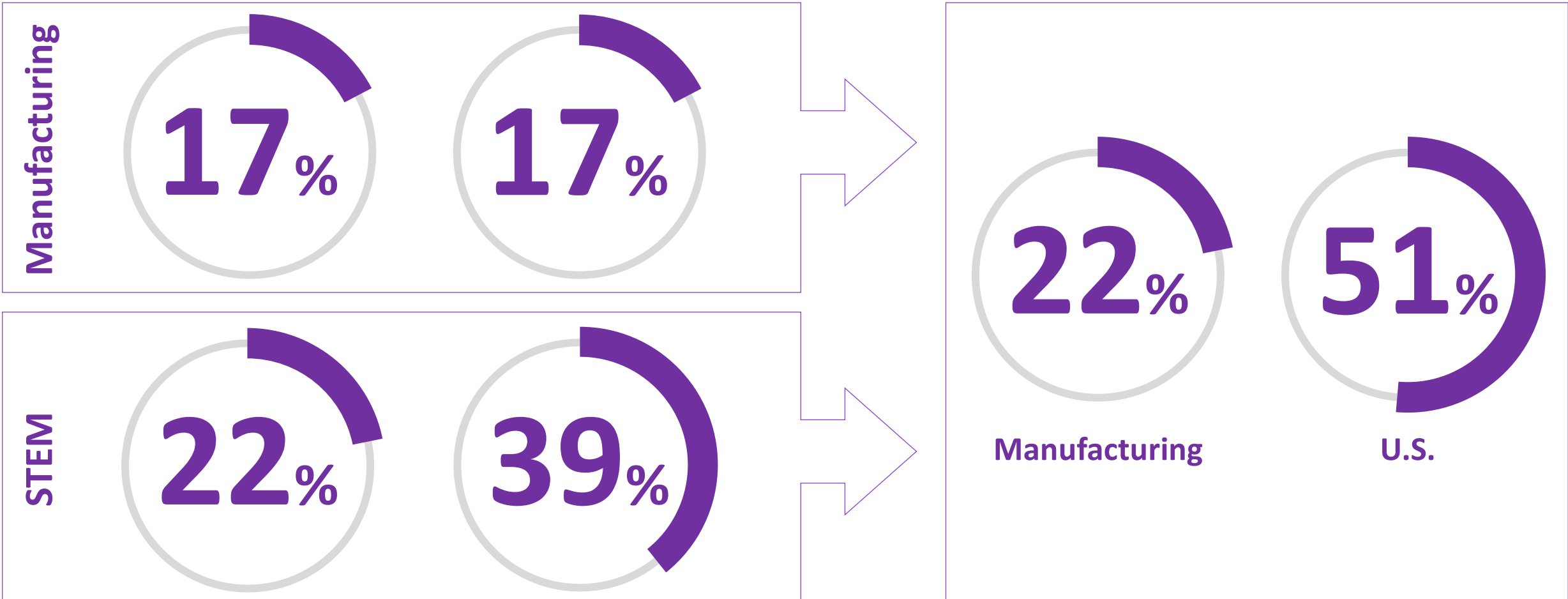

The 2020 Perkins Consolidated Annual Report (CAR), student enrollment was provided by career cluster.





**Chemicals**



**Sustainable Energy**



**Plastics**



**Food & Beverage**

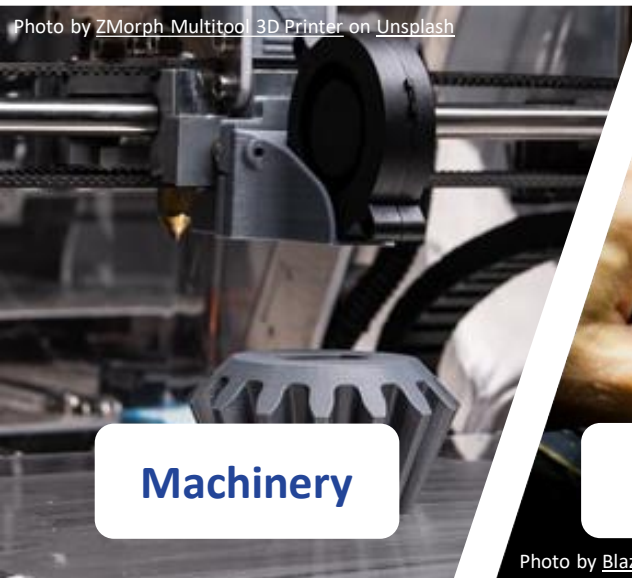

**Machinery**

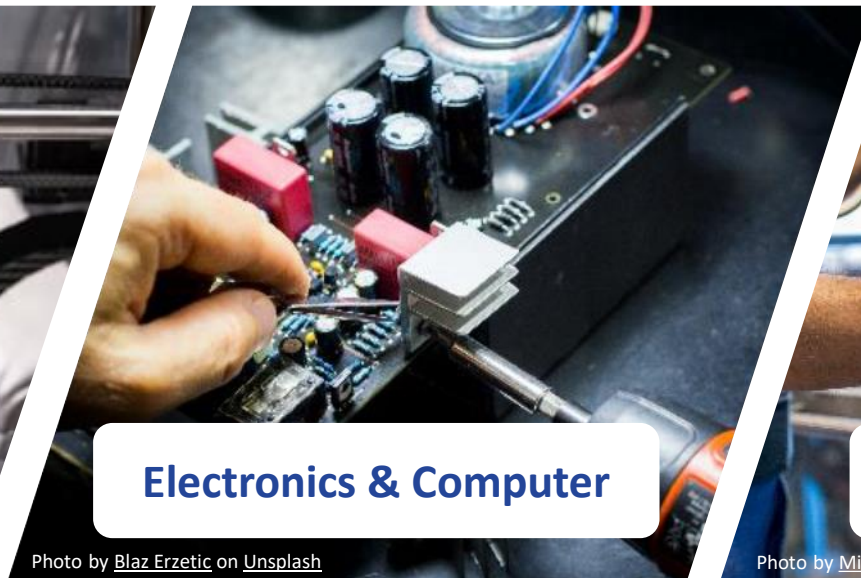

**Electronics & Computer**



**Metals & Finishing**



**Aerospace &  
Transportation**



Automated Machines  
and Robots



Innovation and creative  
problem-solving



Clean, high-tech,  
and safe

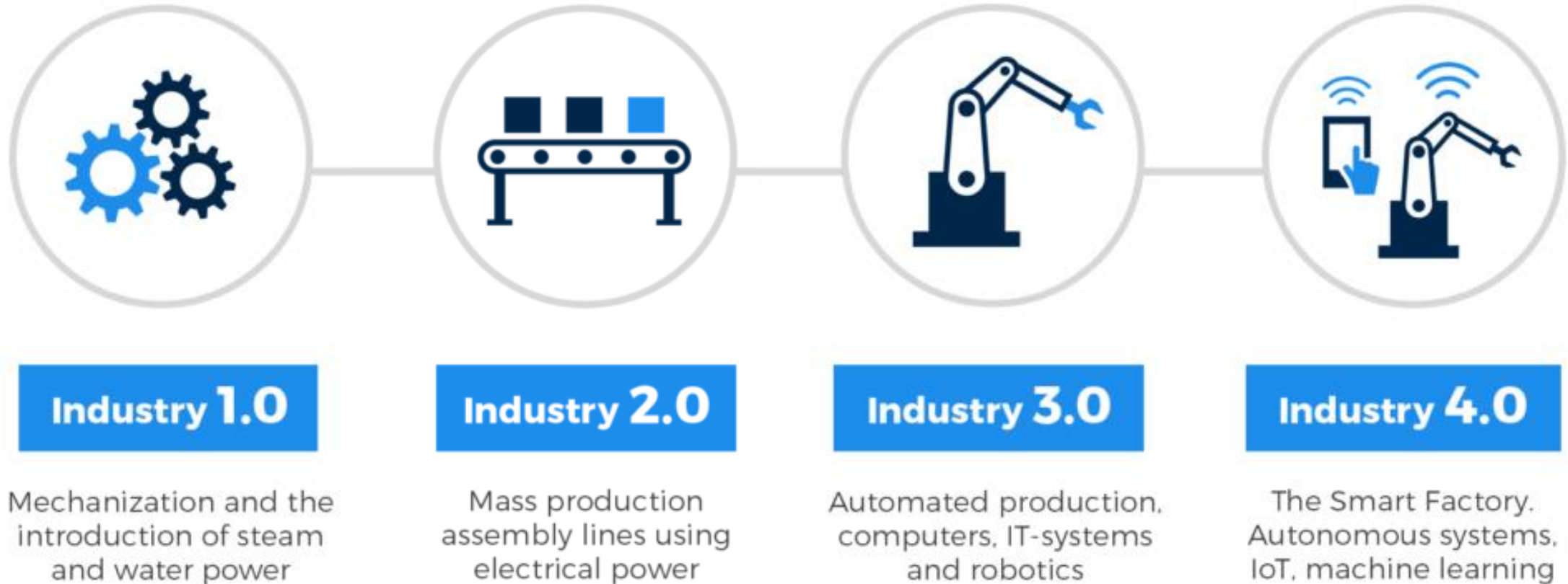
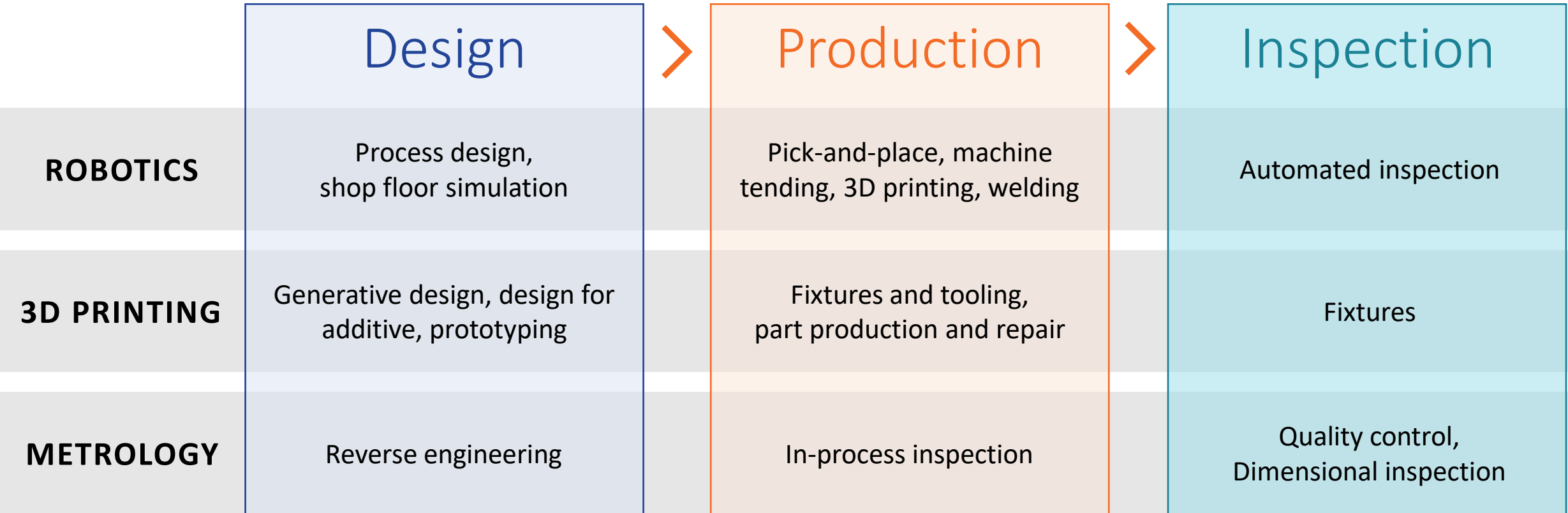

Image from <https://www.spectralengines.com/articles/industry-4-0-and-how-smart-sensors-make-the-difference>



Connectivity



Data and Analytics



Artificial Intelligence

## Design

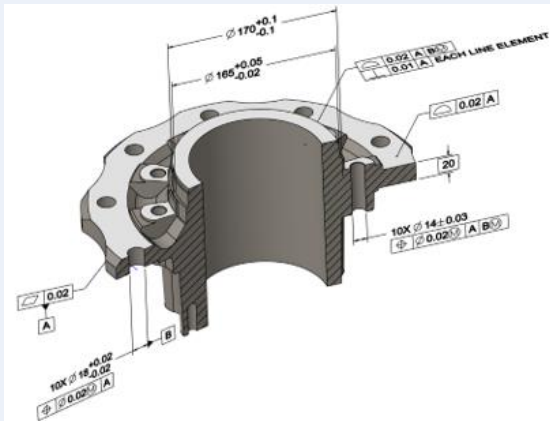

Engineers, Designers,  
Programmers



## Production

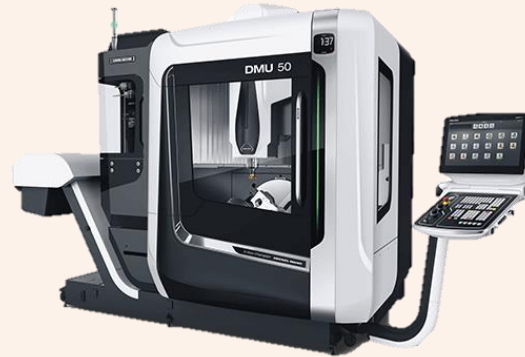

Machinists, Assemblers,  
Maintenance, Welders



## Inspection

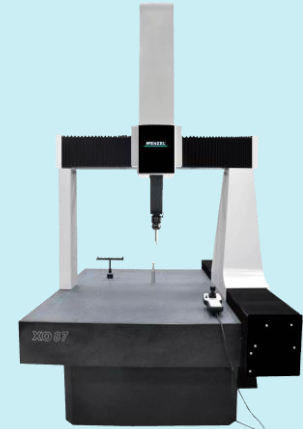

Inspectors, Quality Assurance (QA)/Quality Control (QC)

## Station A

David

### Robotics Polymer 3D Printing

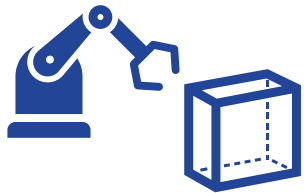

- Industrial and collaborative robotics
- Material extrusion
- Composite printing

## Station B

Sam

### Metal 3D Printing Precision Machining

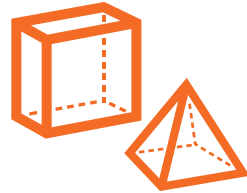

- Directed energy deposition
- Laser Powder Bed Fusion
- Binder Jetting
- High-rate flex cell

## Station C

Kristi

### Metrology

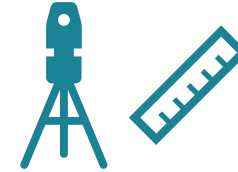

- Coordinate Measuring Machine
- Structured light scanning
- X-Ray and CT scanning
- Thermography

## Station D

Millie & Eileen

### Reflection & Discussion



- Careers and skills
- Classroom connections

Four rotations – 5 min. break after the second rotation



Start with **David**  
(Robotics and Polymer 3D Printing)



Start with **Sam**  
(Metal 3D Printing and Precision Machining)

**Short Break**  
The next rotation will begin at 2:10 PM.





Start with **Kristi**  
(Metrology)



Start with **Millie and Eileen**  
(Reflection & Discussion)

# Reflection & Discussion



**How would you describe  
modern manufacturing?**

## Share one new thing you learned about each area of manufacturing technologies

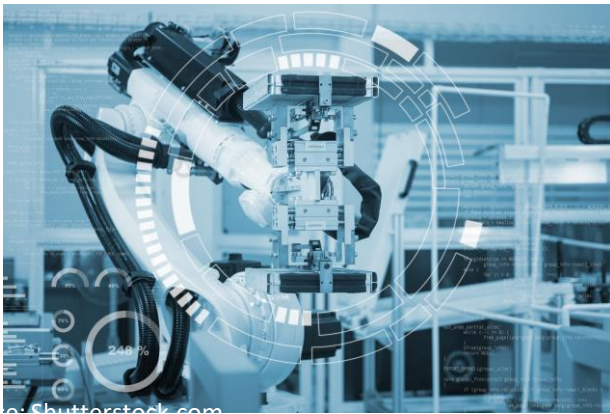

Robotics



Additive Manufacturing

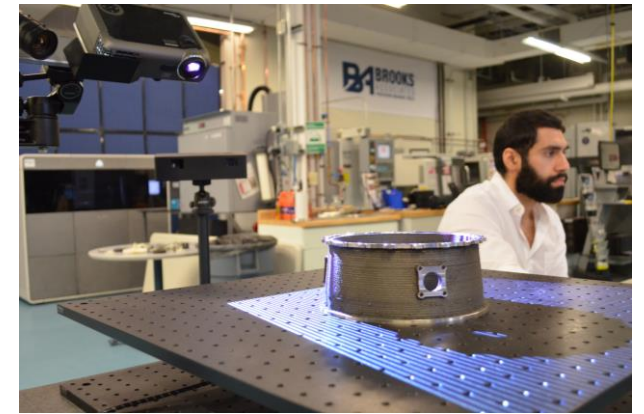

Inspection

What are your key takeaways about the **future** of manufacturing?

What are the **key skills** do you think that your students would need to succeed in manufacturing?

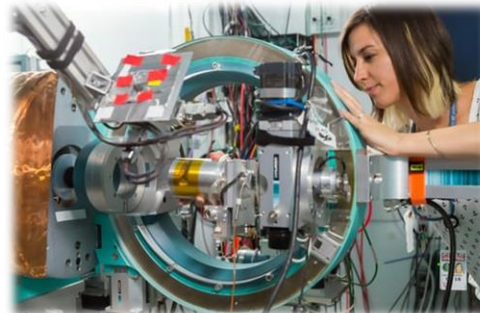
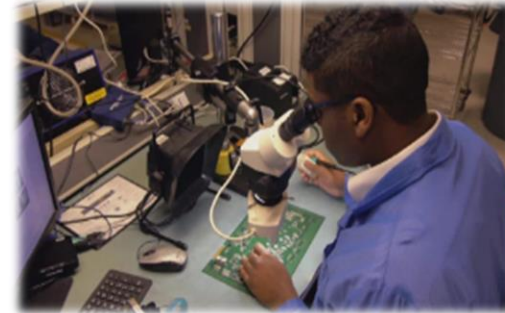

- How will you use what you've seen today to inspire ALL students?
- How will you bring what you learned today into your classroom?

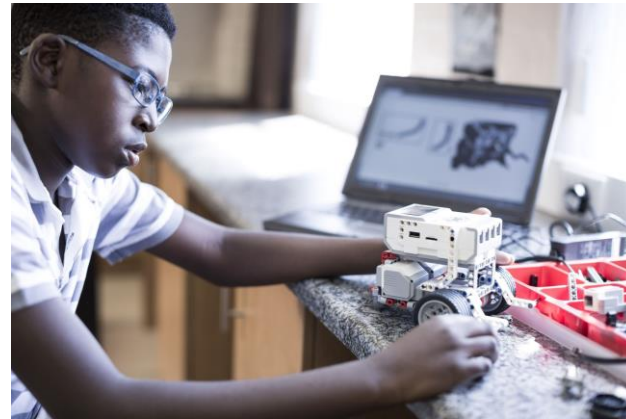
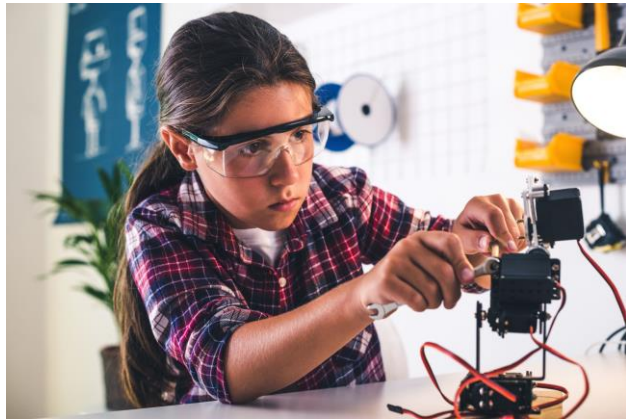

# Resources & Upcoming Opportunities

## CTcreates.org

- Meet CT MFG Companies through recorded videos
- Access Educator Resources online including CSDE materials and Interactive Activities & Games
- Links to resources about Increasing Females in Manufacturing & STEM

**Connecting the Next Generation of Innovators with Connecticut Manufacturing**

- ACMT Company Overview - ACMT, Inc.
- Barnes Group Inc. - Barnes Group Inc.
- Meet the Manufacturers - Bauer, Inc.
- Burt Process Equipment/H... - Burt Process Equipment
- Welcome to Cadence CT - Cadence
- Are you the Next BIG DEAL? - Careers in Aerospace
- An inside look at Carey Ma... - Carey Manufacturing
- Carolina Precision Technol... - Carolina Precision Technologies
- Meet Millie, Production Supervisor

**CAT** Connecticut Center for Advanced Technology, Inc.

## VIRTUAL RESOURCES

FOR EDUCATORS & FAMILIES

All Resources | Interactive Activities | Educational Pathways | Manufacturing Facts | More Online Learning

- Virtual CT MFG Fair - Discover Connecticut manufacturing through virtual tours, interactive activities, and games. [Get Started](#)
- 2021 Guide to Colleges & Careers for Women in STEM - Inform students about critical information regarding their college education and career choices to help set them up for success. [Learn More](#)
- Career Pathways Brochures - Learn about careers in manufacturing throughout CT. Contact us to request printed brochures for a class or event. [Manufacturing Career Pathways](#) [Aerospace Career Pathways](#)
- Cool Stuff Made in Connecticut - Start your journey to a career in manufacturing and learn about products that are made here in CT and the people who make them. [Get Started](#)
- CPTV Making the Future - Meet up-and-coming young talent and learn about their journeys into Connecticut manufacturing. [Learn More](#)
- CT Department of Labor - Student and educator resources from CT DOL. [CT's Manufacturing and Other Middle-Skills Jobs](#) [CT's STEM and Manufacturing Jobs](#)
- CT Manufacturing Facts (2020) - Connecticut manufacturing statistics from the National Association of Manufacturers. [Learn More](#)
- CT Manufacturing Report (2020) - Annual Connecticut Manufacturing Report from CBIA and CONNSTEP. [Learn More](#)





## Manufacturing Cluster and Pathways Resources

- [Today's Skills, Tomorrow's Careers: Career Clusters, Career Pathways, Sample Occupations, and Programs of Study \(ct.gov\)](#)
- [Introducing Students to Manufacturing: Best Practices Guide and Program Resources](#)

## CSDE Professional Learning

- [Career Readiness PD Playlist](#)
- [Apprenticeship Career Path PD Playlist](#)
- [Career Exploration PD Playlist](#)



## Million Women Mentors-CT Virtual Coffee about STEM Pathways (On-Demand)



## CT MFG Month Summit for Educators (On-Demand)



## Intro to Manufacturing Careers for Educators (On-Demand)

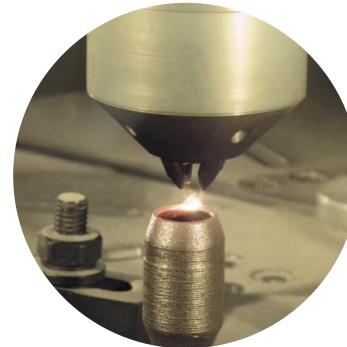

## Intro to 3D Printing Technologies for Educators (On-Demand)

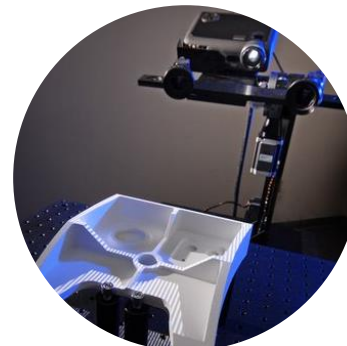

## Modern Inspection Technologies for Educators (On-Demand)

17th Annual  
**WOMEN OF INNOVATION®**

Learn more at [womenofinnovation.org](https://womenofinnovation.org)

**CAT** Connecticut Center for Advanced Technology, Inc.

Connecticut Technology Council  
The Catalyst for Innovation © 2016

## Honoring women who lead Connecticut's future in STEM

Watch the celebration event and learn more about these exceptional women!

Learn more at  
[womenofinnovation.org](https://womenofinnovation.org)

## Inspiring the Next Generation

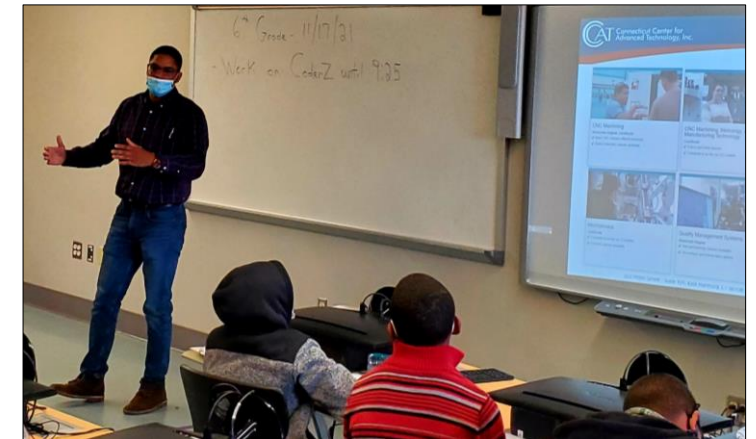

 [ccat.us/ambassadors](https://ccat.us/ambassadors)

 [ecandels@ccat.us](mailto:ecandels@ccat.us)

## Tours

- **Tour Your Advanced Technology Center**  
Thu. Mar. 3, 3-4 pm (In-person)
- **Tour Your Advanced Technology Center  
to Inspire ALL Students (For Educators)**  
Tue. Mar. 15, 1–3 pm (In-person)
- **Tour Your Advanced Technology Center**  
Tue. Apr. 26, 2–3 pm (In-person)

## Webinars

- **Professional Development Series for  
Educators: People, Pathways & Technology  
for the Future Manufacturing Workforce**  
People: Wed. Mar. 2, 1–3 pm (Virtual)  
Pathways: Wed. April 13, 1-3 pm  
Technology: Wed. May 4, 1-3 pm
- **Additive Forum & Technology Showcase**  
Tue. Apr. 19, 8-4 pm (Hybrid)

Watch CCAT's Collection of Technical Workshops On-Demand 24/7 [ccat.us/workshops](https://ccat.us/workshops)

Please take a  
minute to  
complete  
our survey



<https://forms.office.com/r/zgD0bNjbpS>

Thank you!

Leading. Partnering.  
*... for a stronger tomorrow.*



 East Hartford, CT

 [ccat.us/events](http://ccat.us/events)

 CCATInc

**Eileen Candels**

 [ecandels@ccat.us](mailto:ecandels@ccat.us)

**Millie Hemming**

 [mhemming@ccat.us](mailto:mhemming@ccat.us)

 **Facebook** @CTCenterforAdvancedTech

 **Instagram** @ctcenterforadvancedtech

 **LinkedIn** @CCAT

 **Twitter** @CCATInc